

liberi **IN** cucina

listino prezzi price list 01.2023

ALPES

Alpes-Inox s.r.l.
via Monte Pertica, 5
36061 Bassano del Grappa,
Vicenza, Italia
Tel +39 0424 513500
info@alpesinox.com
www.alpesinox.com

Alpes Inox declina ogni
responsabilità per possibili
errori o inesattezze.

Si riserva inoltre
di apportare, in qualsiasi
momento e senza preavviso,
modifiche alle caratteristiche
dei propri prodotti.

I dati forniti non sono
impegnativi.

Per una corretta installazione
consultare e attenersi alle
istruzioni tecniche.

Alpes Inox declines all
responsibility for any
mistakes or inaccuracies.

It reserves the right to make
modifications to its products
at any time without prior
notice. The information
supplied is purely indicative
and not binding.

For correct installation
please see and follow the
technical instructions.

production management

Alpes ufficio marketing

agency

Umbrella, Treviso

photography

Miro Zagnoli

translation

Olga Barmine, Technolab

printing

Chinchio Industria Grafica srl print

on **April 2022**

copyright © Alpes-Inox 2014

5. **70**

7. **100**

9. **130**

11. **160**

13. **190**

17. **220**

19. **250**

21. **280**

XYZ

23. **Colonne**
Columns

27. **Accessori**
Accessories

28. **Outdoor**
Outdoor

29. **Acciaio inox**
Stainless steel

30. **Pulizia dei materiali**
Cleaning the materials

31. **Condizioni di vendita**
General sales conditions

Top inox
S/steel countertop

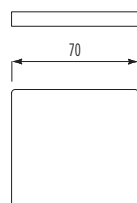

T/70
920

Top Corian®
Corian® countertop

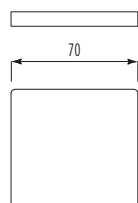

TC/70
920

Top Legno
Wooden countertop

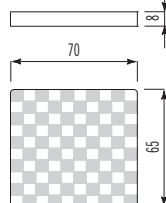

TL/70
2.150

Fori su top inox
Cutout holes on the
s/steel countertop

un foro incasso per lavaggio o cottura
one built-in hole for washing or cooking items

160

un foro incasso filo piano per piani cottura a induzione
one built-in hole for flush-mount induction hobs

270

un foro e saldatura per lavaggio
one hole and welding for washing items

920

un foro per piani cottura ribaltabili
one hole for flip-up hobs

100

Fori su top Corian®
Cutout holes on the
Corian® countertop

un foro incasso per lavaggio
one built-in hole for washing items

160

un foro incasso per cottura
one built-in hole for cooking items

270

un foro per lavaggio o cottura sottopiano o filo piano
one hole for an undermount or flush-mount washing or cooking items

210

un foro per piani cottura ribaltabili
one hole for flip-up hobs

100

Top ed elettrodomestici non sono inclusi nel prezzo dell'elemento di libera installazione. Per gli elettrodomestici fare riferimento al listino "Strumenti d'Oggi".
The countertop and the appliances are not included in the price of the freestanding unit. For appliances, please consult the "Strumenti d'Oggi" price-list.

Elemento libero
Free element

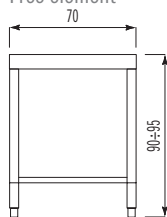

E/70
2.080

Elemento libero con ripiano fisso
Free element with fixed shelf

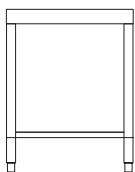

ER/70*
1.950

* L'elemento libero con ripiano fisso è fornito senza fianchi e schienale. The free element with fixed shelf is supplied without sides and back.

Elemento con pannello per lavastoviglie
Element with dishwasher panel

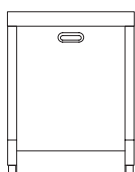

L/70
2.720

Elemento per frigorifero o cantinetta
Element for refrigerator or wine cellar

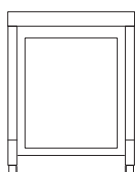

FC/70
2.030

Elemento per forno da 60 cm
Element for oven 60 cm wide

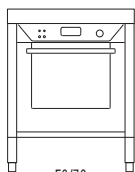

F6/70
2.170

Elemento con anta
Element with door

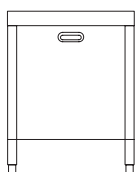

1A/70
2.780

Elementi con cassetti 60 cm
Elements with drawers 60 cm wide

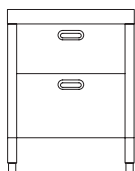

2C/70
3.480

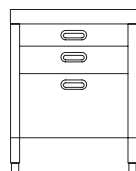

3C/70
3.890

Elementi aperti con ripiani scorrevoli
Open elements with sliding shelves

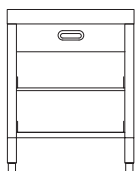

1C2S/70
4.020

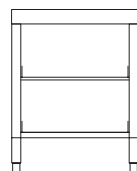

2S/70
3.160

Top inox
S/steel countertop

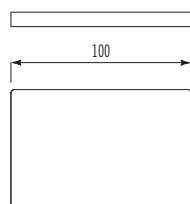

T/100
1.130

Top Corian®
Corian® countertop

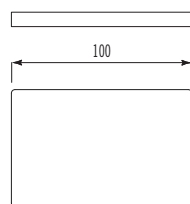

TC/100
1.130

Top legno
Wooden countertop

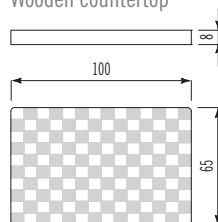

TL/100
2.410

Fori su top inox
Cutout holes on the
s/steel countertop

un foro incasso per lavaggio o cottura
one built-in hole for washing or cooking items

160

un foro incasso filo piano per piani cottura a induzione
one built-in hole for flush-mount induction hobs

270

un foro e saldatura per lavaggio
one hole and welding for washing items

920

un foro per piani cottura ribaltabili
one hole for flip-up hobs

100

Fori su top Corian®
Cutout holes on the
Corian® countertop

un foro incasso per lavaggio
one built-in hole for washing items

160

un foro incasso per cottura
one built-in hole for cooking items

270

un foro per lavaggio o cottura sottopiano o filo piano
one hole for an undermount or flush-mount washing or cooking items

210

un foro per piani cottura ribaltabili
one hole for flip-up hobs

100

Top ed elettrodomestici non sono inclusi nel prezzo dell'elemento di libera installazione. Per gli elettrodomestici fare riferimento al listino "Strumenti d'Oggi".
The countertop and the appliances are not included in the price of the freestanding unit. For appliances, please consult the "Strumenti d'Oggi" price-list.

Elemento libero

Free element

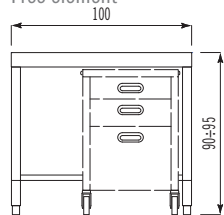

E/100
2.250

Elemento libero con ripiano fisso

Free element with fixing shelf

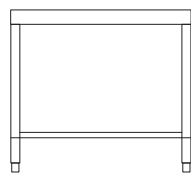

ER/100*
2.180

* L'elemento libero con ripiano fisso è fornito senza fianchi e schienale. The free element with fixed shelf is supplied without sides and back.

Elementi per forno da 60 cm

Elements for oven 60 cm wide

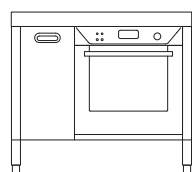

1AF6/100
3.060

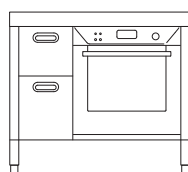

2CF6/100
3.520

Elemento per forno da 90 cm

Element for oven 90 cm wide

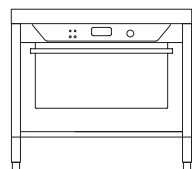

F9/100
2.570

Elemento con ante

Element with doors

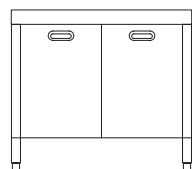

2A/100
3.460

Elementi con cassetti 90 cm

Elements with drawers 90 cm wide

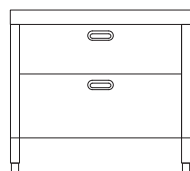

2C/100
3.960

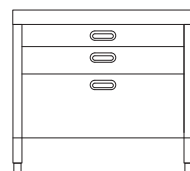

3C/100
4.540

Elemento lavaggio con cassetti 90 cm

Washing element with drawers 90 cm wide

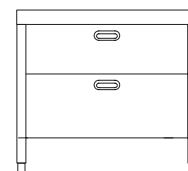

2C-L/100
4.320

Elemento aperto con ripiani scorrevoli 90 cm

Open element with sliding shelves 90 cm wide

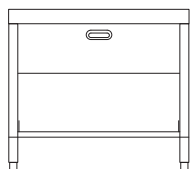

1C1S/100
4.020

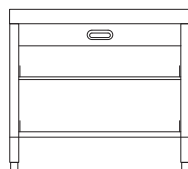

1C2S/100
4.030

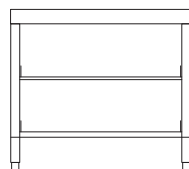

2S/100
3.360

Top inox
Stainless steel countertop

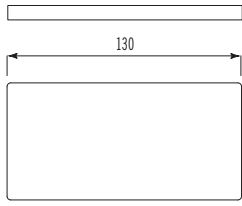

T/130
1.260

Top Corian®
Corian® countertop

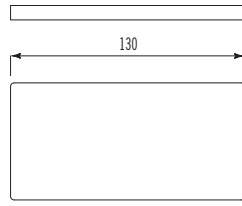

TC/130
1.260

Top legno
Wooden countertop

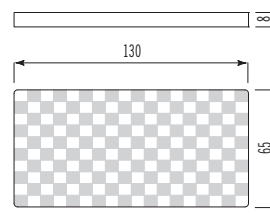

TL/130
3.060

Top inox ad isola
Stainless steel island countertop

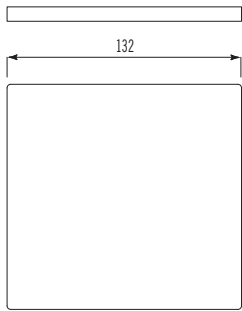

T/130-I
2.830

Top Corian® ad isola
Corian® island countertop

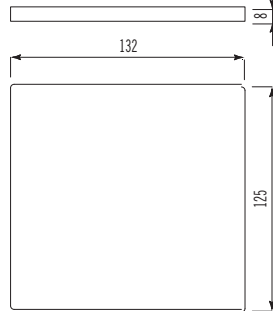

TC/130-I
3.610

Fori su top inox
Cutout holes on the stainless steel countertop

un foro incasso per lavaggio o cottura
one built-in hole for washing or cooking items
160

un foro incasso filo piano per piani cottura a induzione
one built-in hole for flush-mount induction hobs
270

un foro e saldatura per lavaggio
one hole and welding for washing items
920

un foro per piani cottura ribaltabili
one hole for flip-up hobs
100

Fori su top Corian®
Cutout holes on the Corian® countertop

un foro incasso per lavaggio
one built-in hole for washing items
160

un foro incasso per cottura
one built-in hole for cooking items
270

un foro per lavaggio o cottura sottopiano o filo piano
one hole for an undermount or flush-mount washing or cooking items
210

un foro per piani cottura ribaltabili
one hole for flip-up hobs
100

Top ed elettrodomestici non sono inclusi nel prezzo dell'elemento di libera installazione. Per gli elettrodomestici fare riferimento al listino "Strumenti d'Oggi".
The countertop and the appliances are not included in the price of the freestanding unit. For appliances, please consult the "Strumenti d'Oggi" price-list.

Elemento libero

Free element

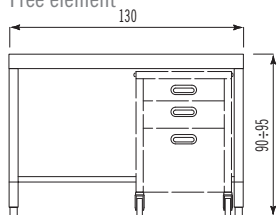

E/130
2.480

Elemento libero con ripiano fisso

Free element with fixed shelf

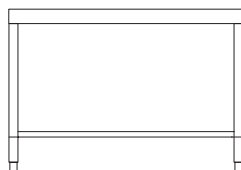

ER/130*
2.470

* L'elemento libero con ripiano fisso è fornito senza fianchi e schienale. The free element with fixed shelf is supplied without sides and back.

Elemento con pannello per lavastoviglie

Element with dishwasher panel

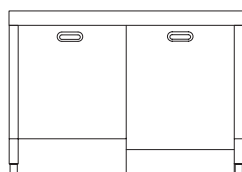

1AL/130
4.020

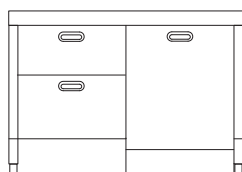

2CL/130
5.300

Elemento libero per due cantinette

Free element for two wine cellars

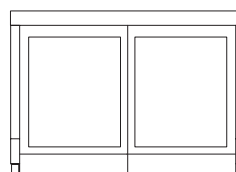

E/130-2FC
2.350

Elementi per forno da 60 cm

Elements for oven 60 cm wide

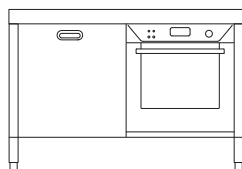

1AF6/130
3.610

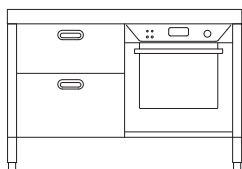

2CF6/130
4.120

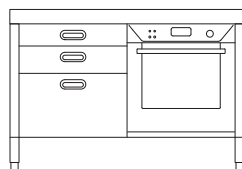

3CF6/130
4.540

Elementi per forno da 90 cm

Elements for oven 90 cm wide

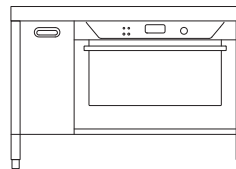

1AF9/130
3.490

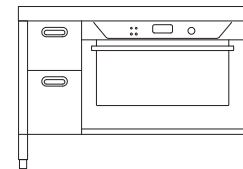

2CF9/130
3.960

Elemento con ante

Element with doors

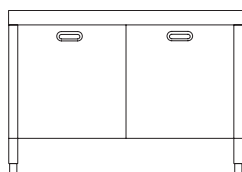

2A/130
4.010

Elementi con cassetti 60 cm

Elements with drawers 60 cm wide

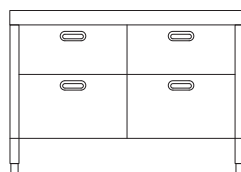

4C/130
5.420

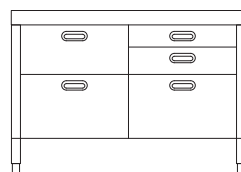

5C/130
5.830

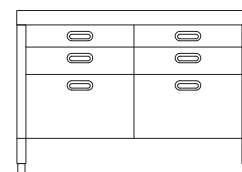

6C/130
6.250

Elementi con cassetti 120 cm

Elements with drawers 120 cm wide

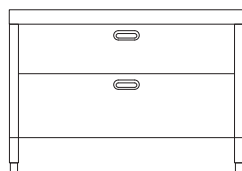

2C/130
4.620

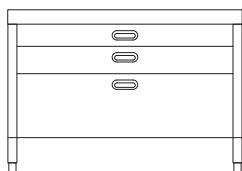

3C/130
5.370

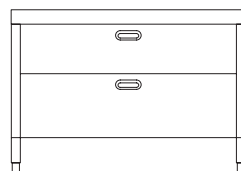

2C-L/130
4.910

Elemento lavaggio con cassetti 120 cm

Washing element with drawers 120 cm wide

Elemento aperto con ripiani scorrevoli 120 cm

Open element with sliding shelves 120 cm wide

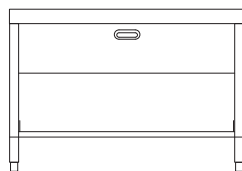

1C1S/130
4.420

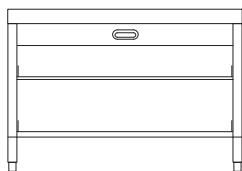

1C2S/130
4.710

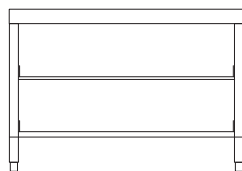

2S/130
3.650

Top inox
Stainless steel countertop

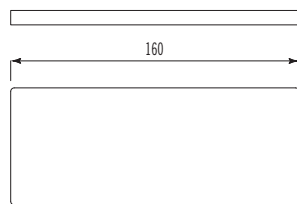

T/160
1.600

Top inox ad isola
Stainless steel island countertop

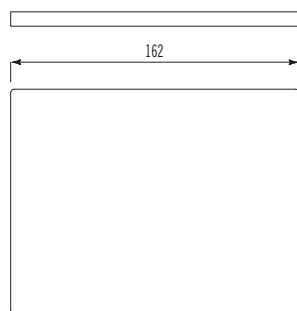

T/160-I
2.930

Top Corian®
Corian® countertop

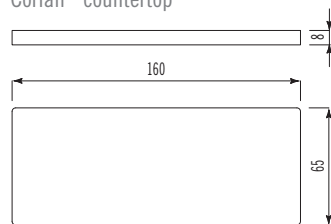

TC/160
1.600

Top Corian® ad isola
Corian® island countertop

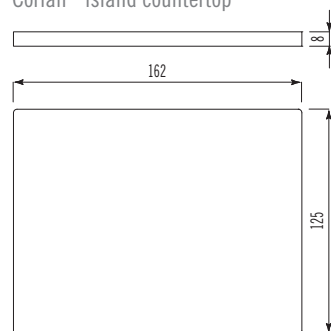

TC/160-I
4.340

Fori su top inox
Cutout holes on the
stainless steel countertop

**un foro incasso per lavaggio
o cottura**
one built-in hole for washing
or cooking items

160

**un foro incasso filo piano per
piani cottura a induzione**
one built-in hole for
flush-mount induction hobs

270

**un foro e saldatura per
lavaggio**
one hole and welding for
washing items

920

**un foro per piani cottura
ribaltabili**

one hole for flip-up
hobs

100

Fori su top Corian®
Cutout holes on the
Corian® countertop

un foro incasso per lavaggio
one built-in hole for washing items

160

un foro incasso per cottura
one built-in hole for cooking items

270

**un foro per lavaggio o cottura
sottopiano o filo piano**
one hole for an undermount or
flush-mount washing or cooking items

210

**un foro per piani cottura
ribaltabili**

one hole for flip-up hobs

100

Top ed elettrodomestici non sono inclusi nel prezzo dell'elemento di libera installazione. Per gli elettrodomestici fare riferimento al listino "Strumenti d'Oggi".
The countertop and the appliances are not included in the price of the freestanding unit. For appliances, please consult the "Strumenti d'Oggi" price-list.

Elemento libero
Free element

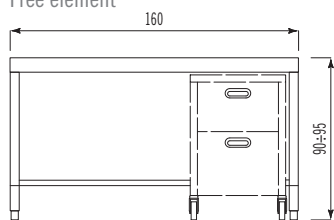

E/160
2.590

Elemento libero con ripiano fisso
Free element with fixed shelf

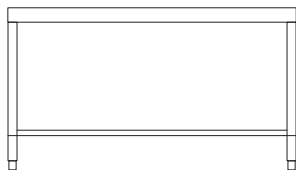

ER/160*
2.700

* L'elemento libero con ripiano fisso è fornito senza fianchi e schienale. The free element with fixed shelf is supplied without sides and back.

Elementi con pannello per lavastoviglie
Elements with dishwasher panel

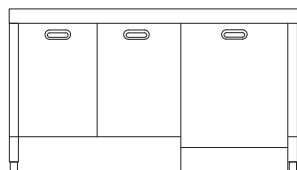

2AL/160
4.640

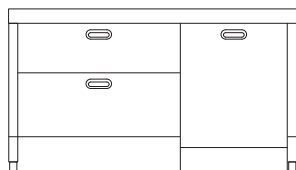

2CL/160
5.550

Elementi per forno da 60 cm
Elements for oven 60 cm wide

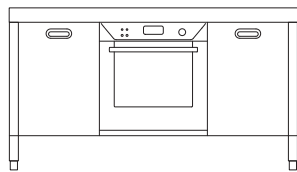

2AF6G/160
4.380

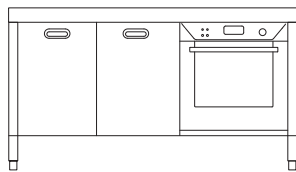

2AF6/160
4.220

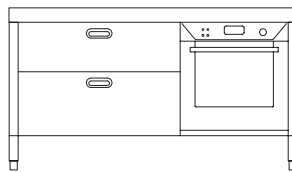

2CF6/160
4.550

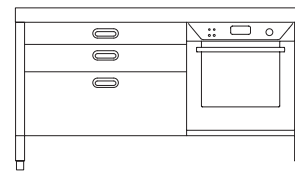

3CF6/160
5.090

Elementi per forno da 90 cm
Elements for oven 90 cm wide

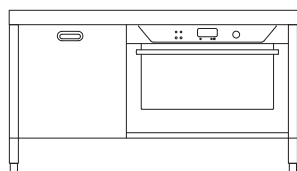

1AF9/160
3.910

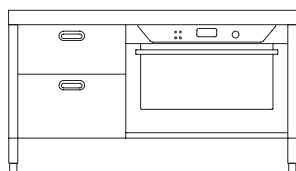

2CF9/160
4.380

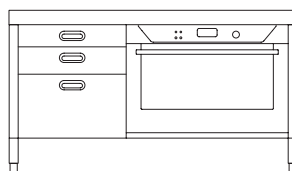

3CF9/160
4.830

Elementi con cassetti 60-90 cm
Elements with drawers 60-90 cm wide

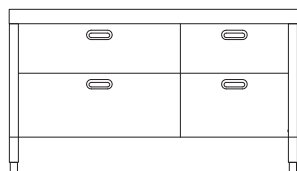

2C9-2C6/160
5.860

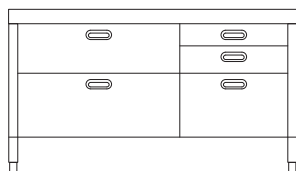

2C9-3C6/160
6.270

Elemento aperto con ripiani scorrevoli 60-90 cm
Open element with sliding shelves 60-90 cm wide

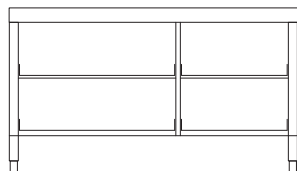

2S9-2S6/160
4.950

Top inox
Stainless steel countertop

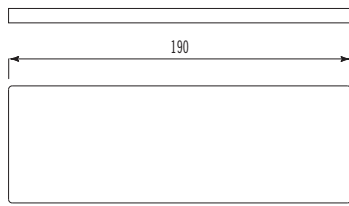

T/190
1.760

Top Corian®
Corian® countertop

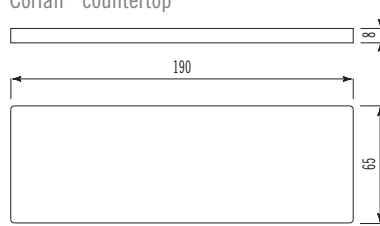

TC/190
1.760

Top inox ad isola
Stainless steel island countertop

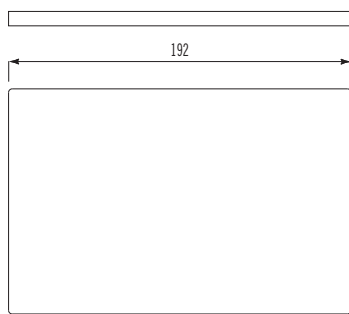

T/190-I
2.990

Top Corian® ad isola
Corian® island countertop

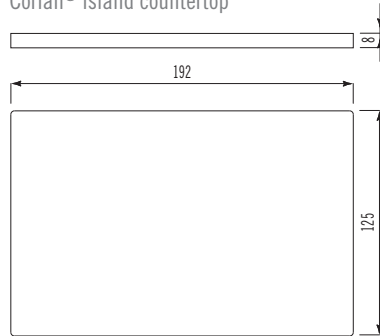

TC/190-I
4.790

Fori su top inox
Cutout holes on the
stainless steel countertop

**un foro incasso per
lavaggio o cottura**
one built-in hole for
washing or cooking items
160

**un foro incasso filo piano per
piani cottura a induzione**
one built-in hole for
flush-mount induction hobs
270

**un foro e saldatura per
lavaggio**
one hole and welding for
washing items
920

**un foro per piani cottura
ribaltabili**
one hole for flip-up
hobs
100

Fori su top Corian®
Cutout holes on the
Corian® countertop

un foro incasso per lavaggio
one built-in hole for washing items
160

un foro incasso per cottura
one built-in hole for cooking items
270

**un foro per lavaggio o cottura
sottopiano o filo piano**
one hole for an undermount or
flush-mount washing or cooking items
210

**un foro per piani cottura
ribaltabili**
one hole for flip-up hobs
100

Top ed elettrodomestici non sono inclusi nel prezzo dell'elemento di libera installazione. Per gli elettrodomestici fare riferimento al listino "Strumenti d'Oggi".
The countertop and the appliances are not included in the price of the freestanding unit. For appliances, please consult the "Strumenti d'Oggi" price-list.

Elemento libero
Free element

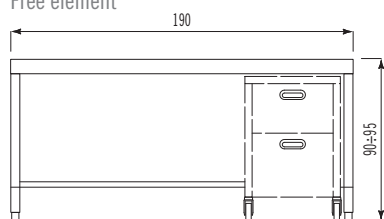

E/190
2.930

Elemento libero con ripiano fisso
Free element with fixed shelf

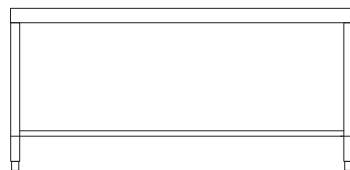

ER/190*
3.000

* L'elemento libero con ripiano fisso è fornito senza fianchi e schienale. The free element with fixed shelf is supplied without sides and back.

Elementi con pannello per lavastoviglie
Elements with dishwasher panel

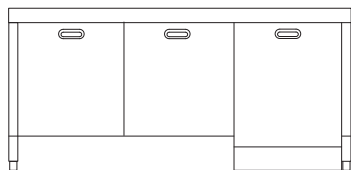

2AL/190
4.910

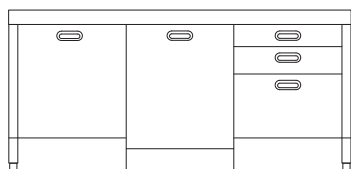

1AL3C/190
6.160

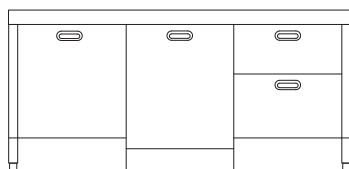

1AL2C/190
5.770

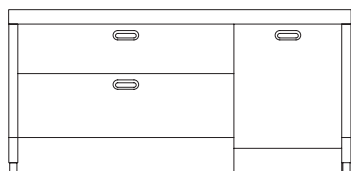

2CL/190
6.270

Elemento con pannello per lavastoviglie e forno da 60 cm
Element with dishwasher panel and oven 60 cm wide

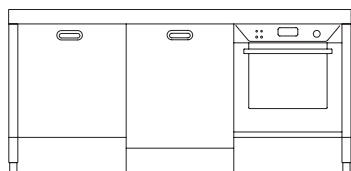

1ALF6/190
4.460

Elementi per forno da 60 cm
Elements for oven 60 cm wide

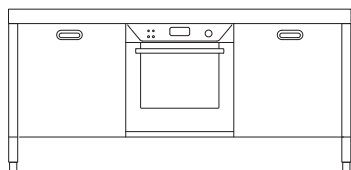

2AF6C/190
4.880

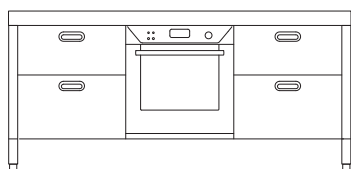

4CF6C/190
6.100

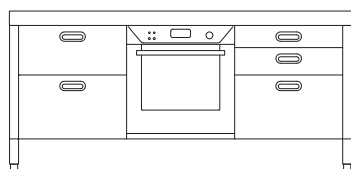

5CF6C/190
6.530

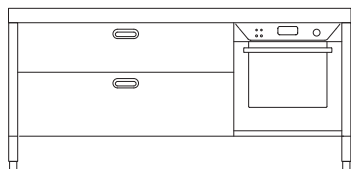

2CF6/190
5.310

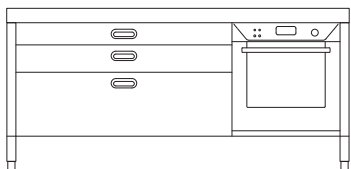

3CF6/190
6.050

Elementi per forno da 90 cm
Elements for oven 90 cm wide

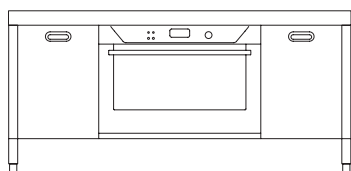

2AF9C/190
7.820

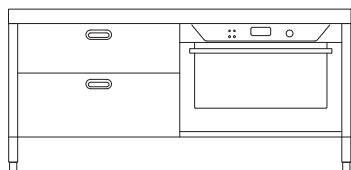

2CF9/190
5.160

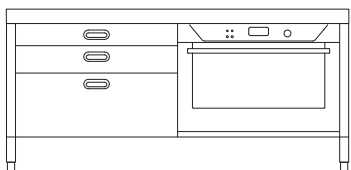

3CF9/190
5.710

Elemento con ante
Element with doors

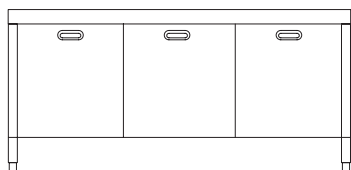

3A/190
5.530

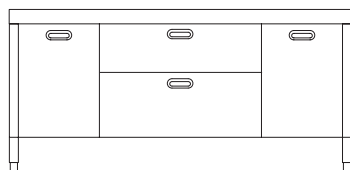

2A2C9/190
6.980

Elementi con cassetti 60 cm
Elements with drawers 60 cm wide

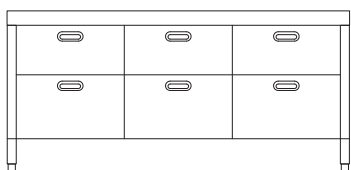

6C6/190
7.570

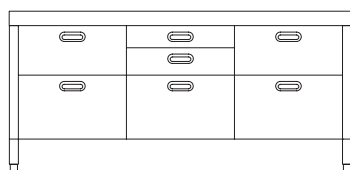

7C/190
7.990

Elementi con cassetti 60-120 cm
Elements with drawers 60-120 cm wide

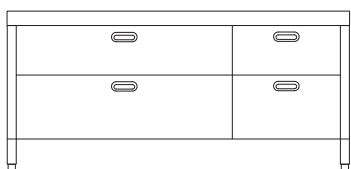

2C12-2C6/190
6.700

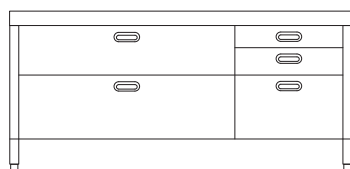

2C12-3C6/190
7.110

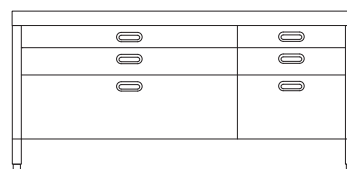

3C12-3C6/190
7.840

Elementi con cassetti 90 cm
Elements with drawers 90 cm wide

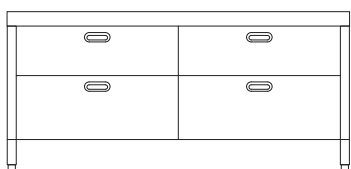

4C/190
6.560

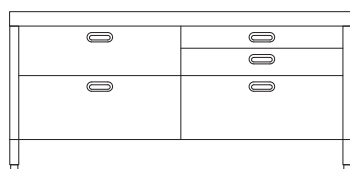

5C/190
7.120

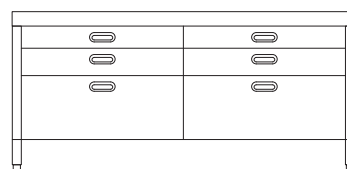

6C/190
7.670

Elemento aperto con cassetti 90 cm e ripiano fisso
Open element with drawers 90 cm wide and fixed shelf

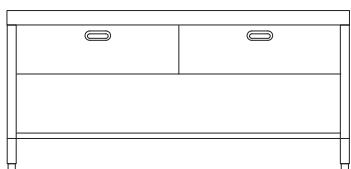

2C1R/190
5.520

Elementi aperti con cassetti e ripiani scorrevoli 90 cm
Open elements with drawers and sliding shelves 90 cm wide

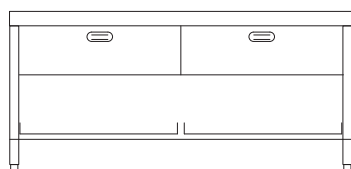

2C2S/190
6.710

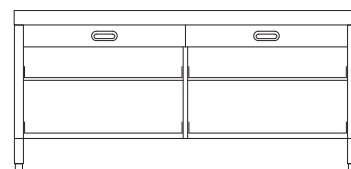

2C4S/190
7.330

Elemento aperto con ripiani scorrevoli 60 cm
Open element with sliding shelves 60 cm wide

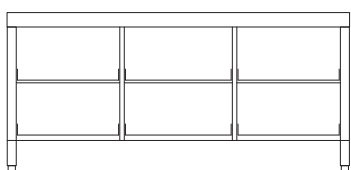

6S/190
5.990

Elemento aperto con ripiani scorrevoli 90 cm
Open element with sliding shelves 90 cm wide

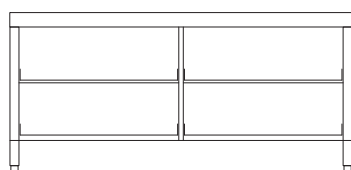

4S/190
5.490

Top inox
Stainless steel countertop

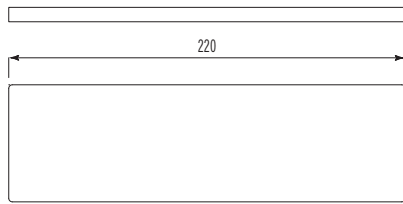

T/220
1.970

Top Corian®
Corian® countertop

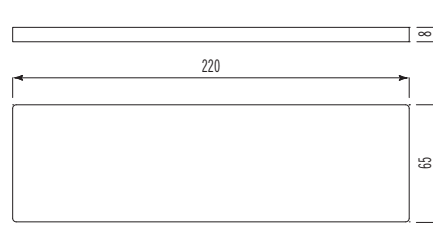

TC/220
1.970

Top inox ad isola
Stainless steel island countertop



T/220-I
3.150

Top Corian® ad isola
Corian® island countertop

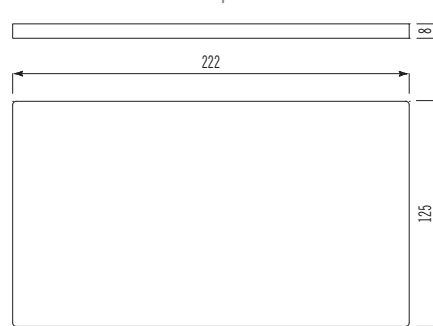

TC/220-I
5.570

Fori su top inox
Cutout holes on the
stainless steel countertop

un foro incasso per
lavaggio o cottura
one built-in hole for
washing or cooking items
160

un foro incasso filo piano per
piani cottura a induzione
one built-in hole for
flush-mount induction hobs
270

un foro e saldatura per
lavaggio
one hole and welding for
washing items
920

un foro per piani cottura
ribaltabili
one hole for flip-up
hobs
100

Fori su top Corian®
Cutout holes on the
Corian® countertop

un foro incasso per lavaggio
one built-in hole for washing items
160

un foro incasso per cottura
one built-in hole for cooking items
270

un foro per lavaggio o cottura
sottopiano o filo piano
one hole for an undermount or
flush-mount washing or cooking items
210

un foro per piani cottura
ribaltabili
one hole for flip-up hobs
100

Top ed elettrodomestici non sono inclusi nel prezzo dell'elemento di libera installazione. Per gli elettrodomestici fare riferimento al listino "Strumenti d'Oggi".
The countertop and the appliances are not included in the price of the freestanding unit. For appliances, please consult the "Strumenti d'Oggi" price-list.

Elementi con pannello per lavastoviglie
Elements with dishwasher panel

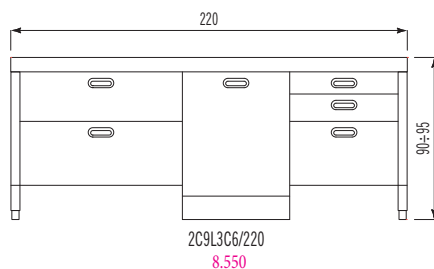
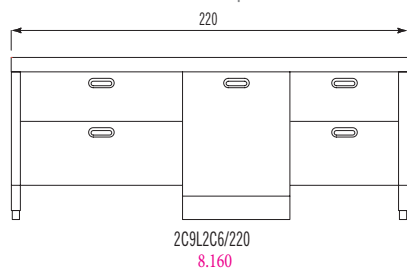

Elemento con pannello per lavastoviglie e forno da 60 cm
Element with dishwasher panel and oven 60 cm wide

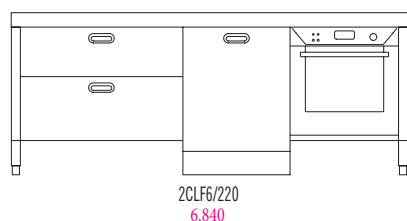

Elemento con pannello per lavastoviglie e forno da 90 cm
Element with dishwasher panel and oven 90 cm wide

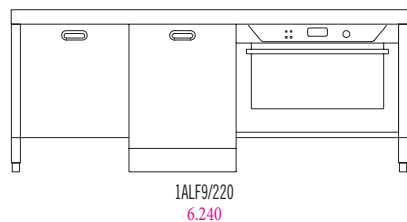

Elemento per forno da 90 cm
Element for oven 90 cm wide

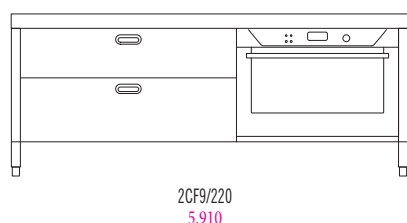

Elemento con cassetti 90-120 cm
Element with drawers 90-120 cm wide

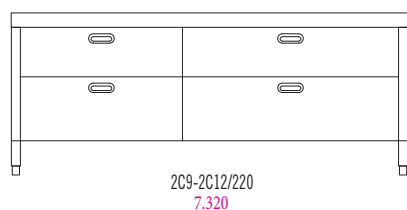

Elemento con cassetti 60-90 cm
Element with drawers 60-90 cm wide

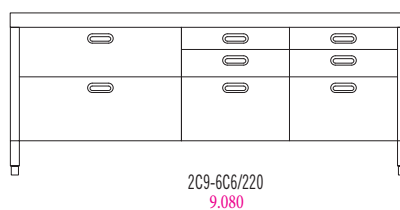

Elemento aperto con ripiani scorrevoli 90 e 120 cm
Open element with sliding shelves 90 and 120 cm wide

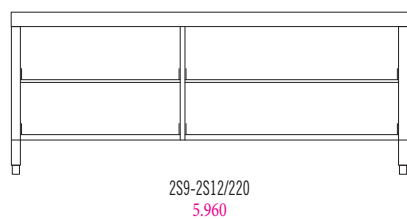

Elemento aperto con ripiani scorrevoli 90 cm e cassetti 30 cm
Open element with sliding shelves 90 cm and drawers 30 cm wide

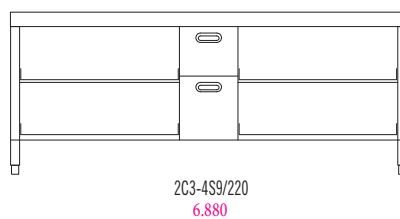

Top inox
Stainless steel countertop

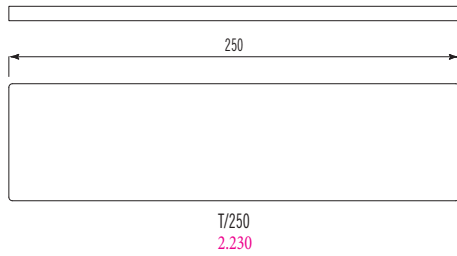

Top Corian®
Corian® countertop

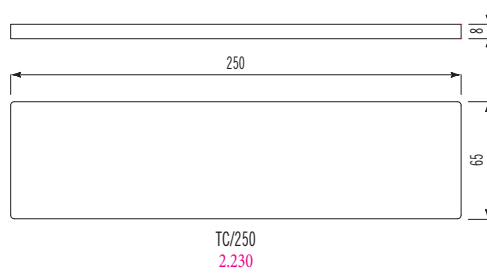

Top inox ad isola
Stainless steel island countertop

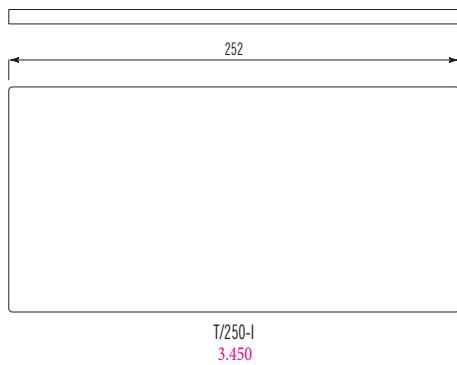

Top Corian® ad isola
Corian® island countertop

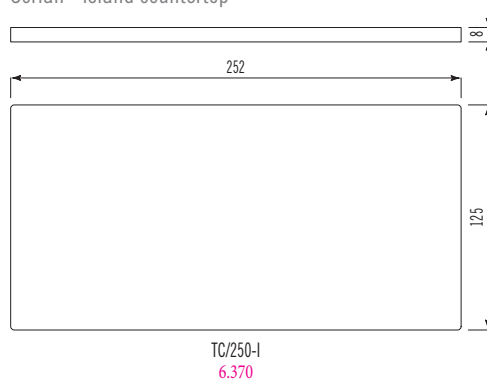

Fori su top inox
Cutout holes on the
stainless steel countertop

un foro incasso per lavaggio o cottura
one built-in hole for washing or cooking items
160

un foro incasso filo piano per piani cottura a induzione
one built-in hole for flush-mount induction hobs
270

un foro e saldatura per lavaggio
one hole and welding for washing items
920

un foro per piani cottura ribaltabili
one hole for flip-up hobs
100

Fori su top Corian®
Cutout holes on the
Corian® countertop

un foro incasso per lavaggio
one built-in hole for washing items
160

un foro incasso per cottura
one built-in hole for cooking items
270

un foro per lavaggio o cottura sottopiano o filo piano
one hole for an undermount or flush-mount washing or cooking items
210

un foro per piani cottura ribaltabili
one hole for flip-up hobs
100

Top ed elettrodomestici non sono inclusi nel prezzo dell'elemento di libera installazione. Per gli elettrodomestici fare riferimento al listino "Strumenti d'Oggi".
The countertop and the appliances are not included in the price of the freestanding unit. For appliances, please consult the "Strumenti d'Oggi" price-list.

Elemento con pannello per lavastoviglie
Element with dishwasher panel

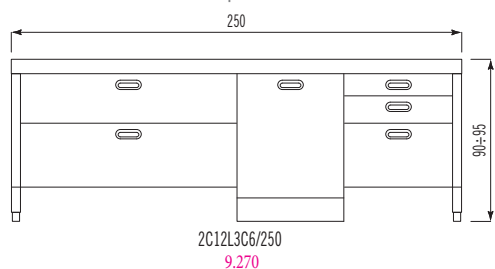

Elemento con pannello per lavastoviglie e forno da 60 cm
Element with dishwasher panel and oven 60 cm wide

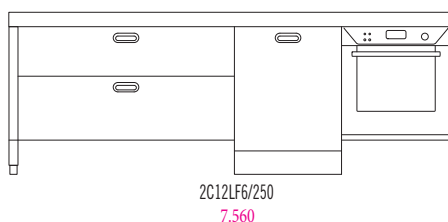

Elemento con pannello per lavastoviglie e forno da 90 cm
Element with dishwasher panel and oven 90 cm wide

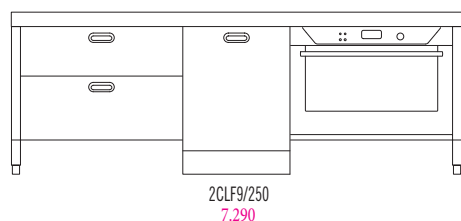

Elemento con ante
Element with doors

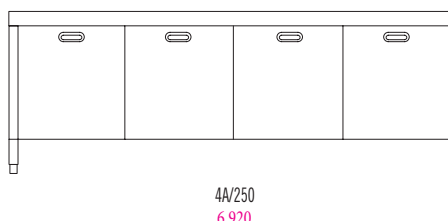

Elemento con cassetti 60 cm
Element with drawers 60 cm wide

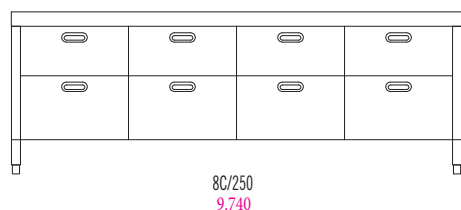

Elementi con cassetti 60-90 cm
Elements with drawers 60-90 cm wide

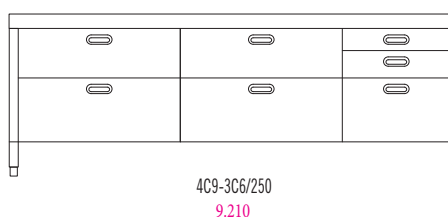

Elementi con cassetti 120 cm
Elements with drawers 120 cm wide

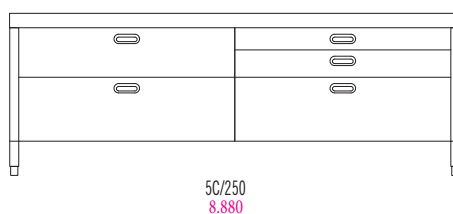
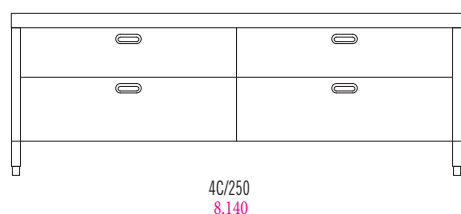

Elemento aperto con cassetti 120 cm e ripiano fisso
Open element with drawers 120 cm wide and fixed shelf

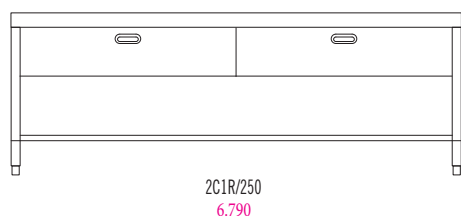

Elementi aperti con cassetti e ripiani scorrevoli 120 cm Open elements with drawers and sliding shelves 120 cm wide

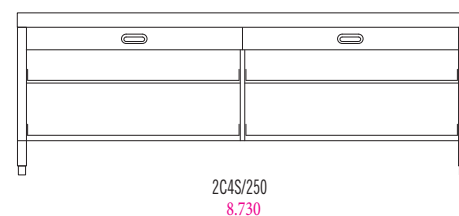
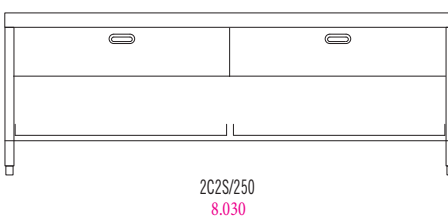

Elemento aperto con ripiani scorrevoli 120 cm
Open element with sliding shelves 120 cm wide

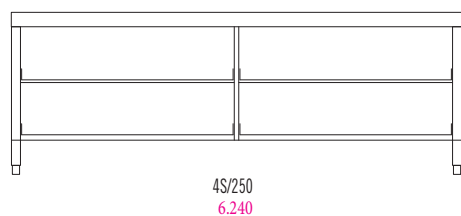

Top inox
Stainless steel countertop

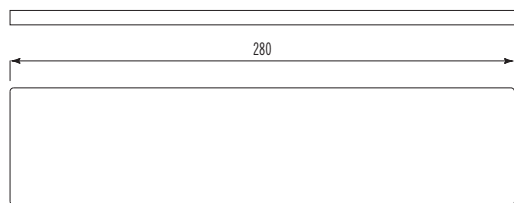

T/280
2.470

Top Corian®
Corian® countertop

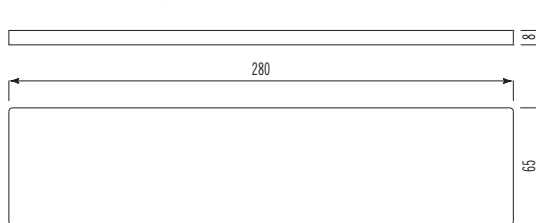

TC/280
2.470

Top inox ad isola
Stainless steel island countertop

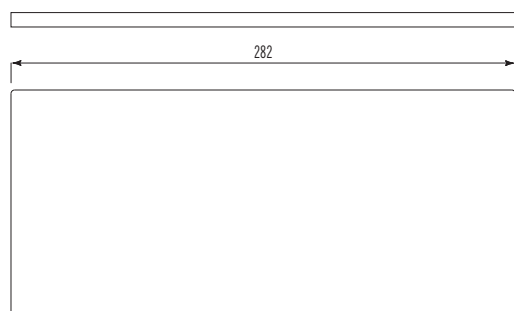

T/280-I
3.690

Top Corian® ad isola
Corian® island countertop

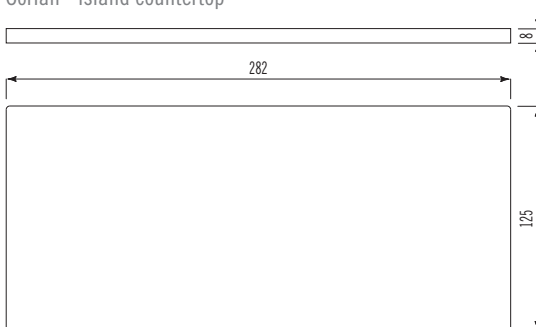

TC/280-I
7.100

Fori su top inox
Cutout holes on the
stainless steel countertop

un foro incasso per
lavaggio o cottura
one built-in hole for
washing or cooking items
160

un foro incasso filo piano per
piani cottura a induzione
one built-in hole for
flush-mount induction hobs
270

un foro e saldatura per
lavaggio
one hole and welding for
washing items
920

un foro per piani cottura
ribaltabili
one hole for flip-up
hobs
100

Fori su top Corian®
Cutout holes on the
Corian® countertop

un foro incasso per lavaggio
one built-in hole for washing items
160

un foro incasso per cottura
one built-in hole for cooking items
270

un foro per lavaggio o cottura
sottopiano o filo piano
one hole for an undermount or
flush-mount washing or cooking items
210

un foro per piani cottura
ribaltabili
one hole for flip-up hobs
100

Top ed elettrodomestici non sono inclusi nel prezzo dell'elemento di libera installazione. Per gli elettrodomestici fare riferimento al listino "Strumenti d'Oggi".
The countertop and the appliances are not included in the price of the freestanding unit. For appliances, please consult the "Strumenti d'Oggi" price-list.

Elemento con pannello per lavastoviglie e forno da 60 cm
Element with dishwasher panel and oven 60 cm wide

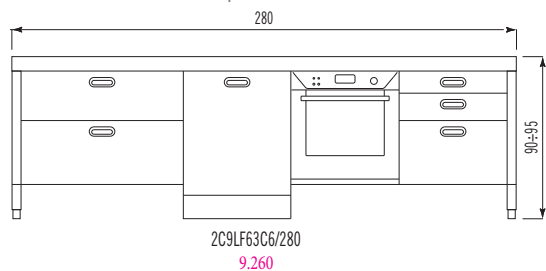

Elemento con pannello per lavastoviglie e forno da 90 cm
Element with dishwasher panel and oven 90 cm wide

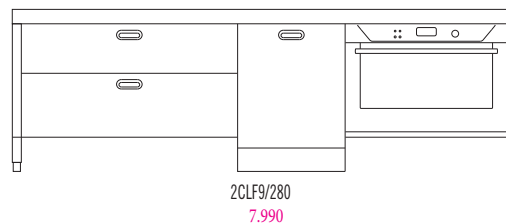

Elemento per forno da 60 cm
Element for oven 60 cm wide

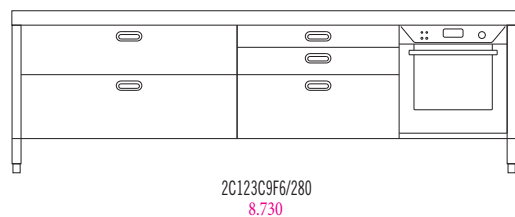

Elemento per forno da 90 cm
Element for oven 90 cm wide

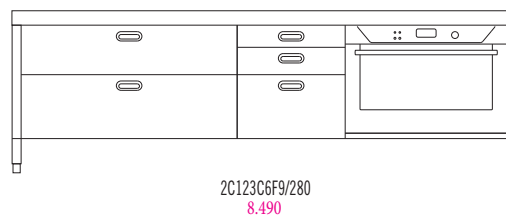

Elemento con cassetti 60-90-120 cm
Element with drawers 60-90-120 cm wide

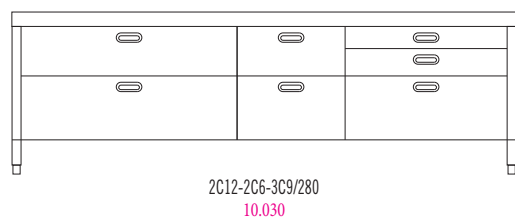

Elemento con cassetti 90 cm
Element with drawers 90 cm wide

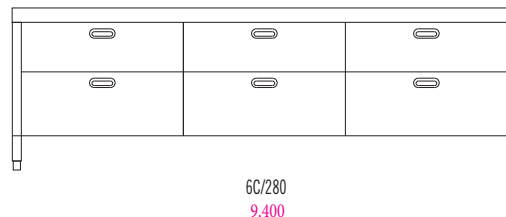

Elementi aperti con cassetti e ripiani scorrevoli 90 cm Open elements with drawers and sliding shelves 90 cm wide

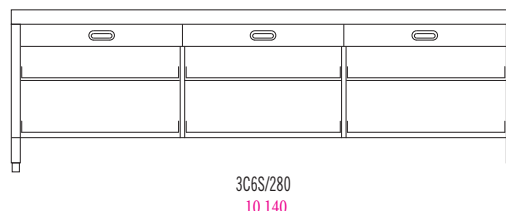
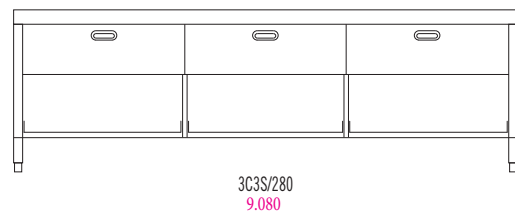

Elemento aperto con ripiani scorrevoli 90 cm Open element with sliding shelves 90 cm wide

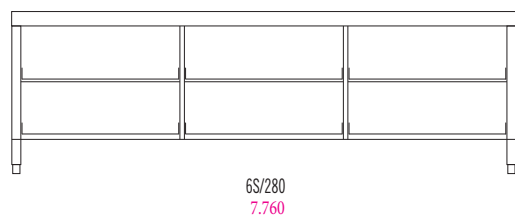

Colonne lavaggio - cottura e refrigerazione
Washing - cooking and refrigeration columns

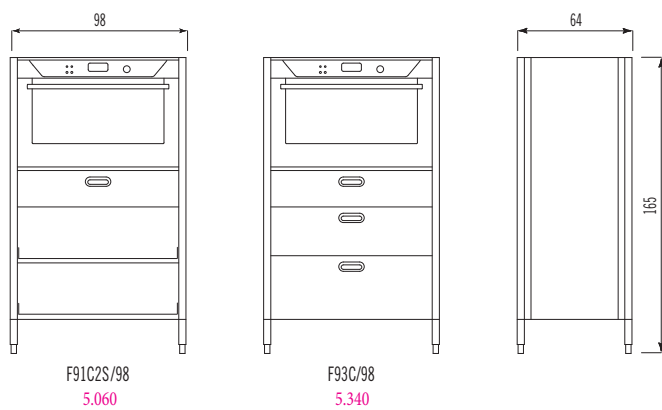
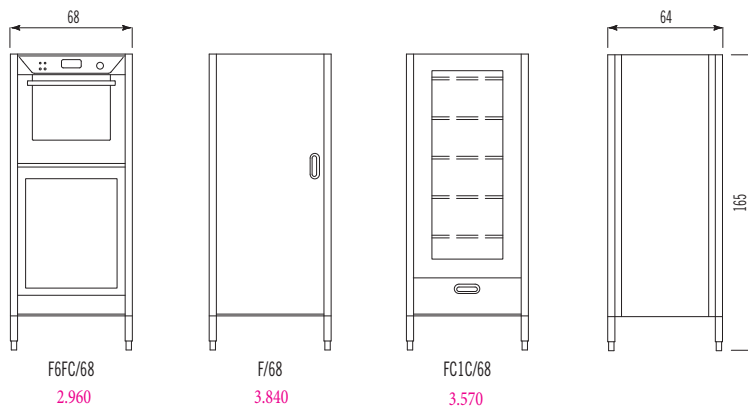
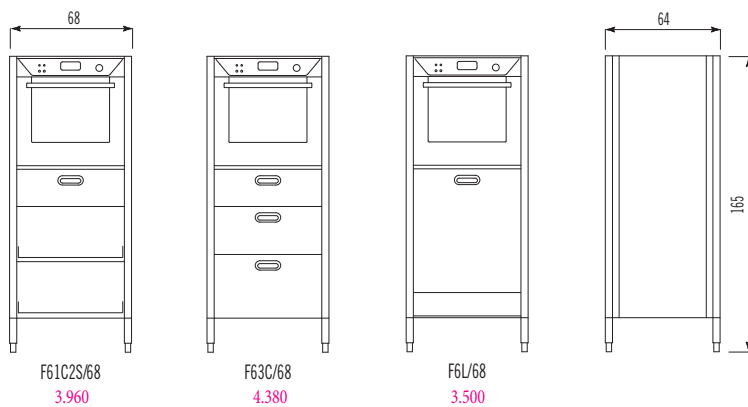

Gli elettrodomestici non sono inclusi nel prezzo dell'elemento di libera installazione. Fare riferimento al listino "Strumenti d'Oggi".
The household appliances are not included in the price of the freestanding unit. For appliances please consult the "Strumenti d'Oggi" price-list.

COLONNE

COLUMNS

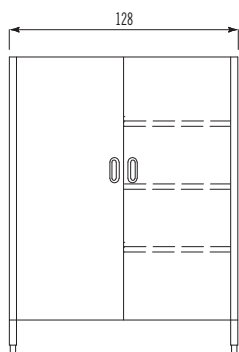

F4R/128
6.630

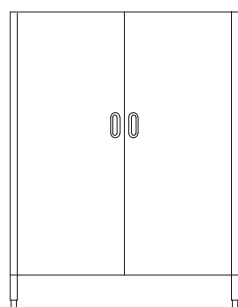

2F/128
5.860

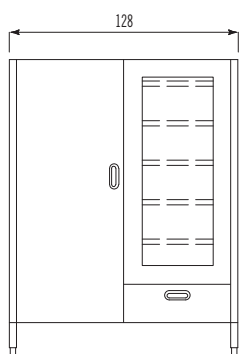
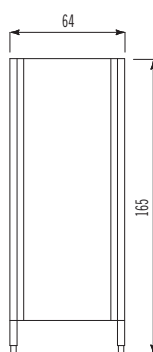

FFC1C/128
5.590

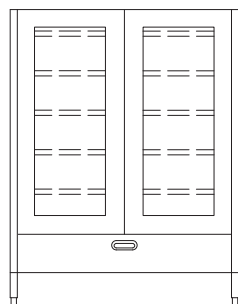

2FC1C/128
5.190

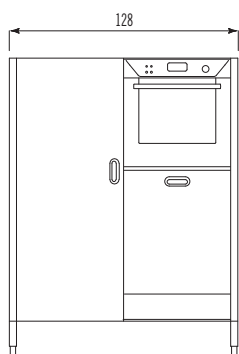
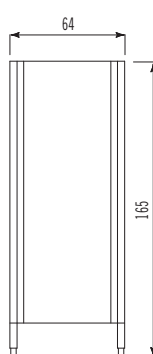

FF6L/128
5.750

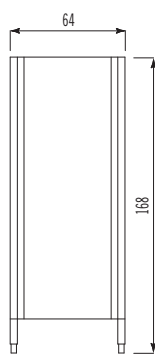

Colonne contenimento - h. 165 cm
Storage columns - 165 cm high

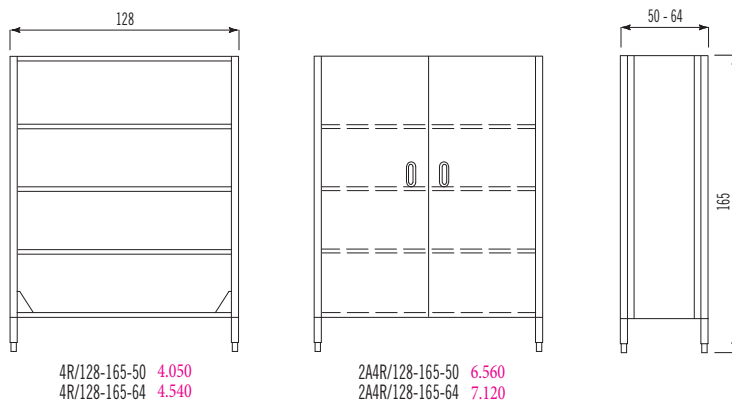
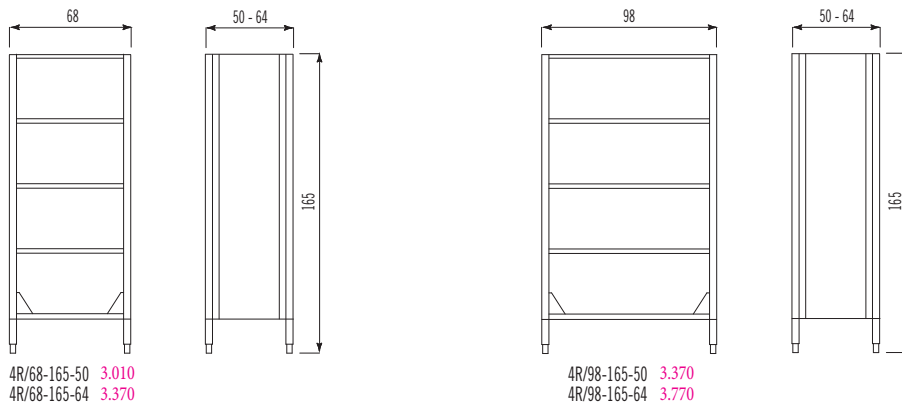

Fianchi e posteriore non sono previsti negli elementi con soli ripiani. I ripiani sono regolabili in altezza.
Elements with shelves only do not feature any side or back walls. The shelves in the storage elements are height adjustable.

COLONNE

COLUMNS

Colonne contenimento - h. 185 cm
Storage columns - 185 cm high

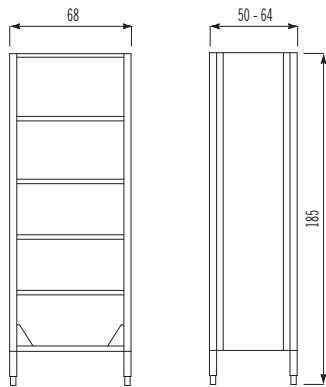

5R/68-185-50 3.290
5R/68-185-64 3.630

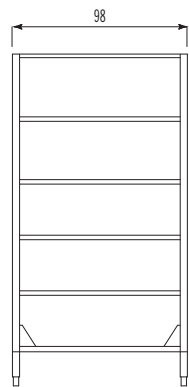

5R/98-185-50 3.570
5R/98-185-64 3.960

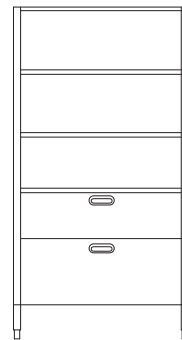

2C3R/98-185-50 5.670
2C3R/98-185-64 6.240

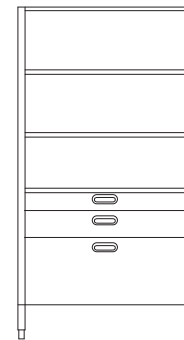

3C3R/98-185-50 6.300
3C3R/98-185-64 6.770

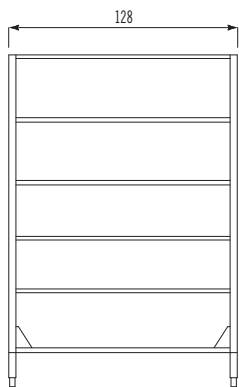
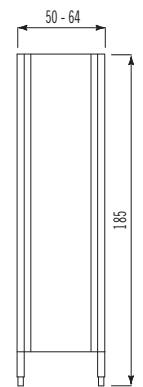

5R/128-185-50 4.380
5R/128-185-64 4.790

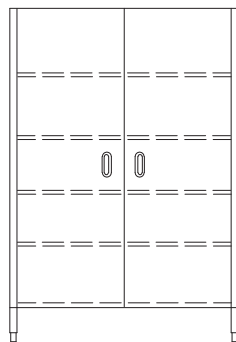

2A5R/128-185-50 7.120
2A5R/128-185-64 7.790

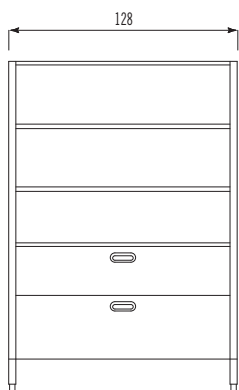
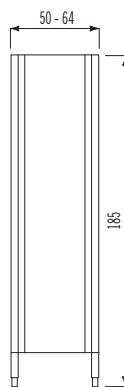

2C3R/128-185-50 6.150
2C3R/128-185-64 6.770

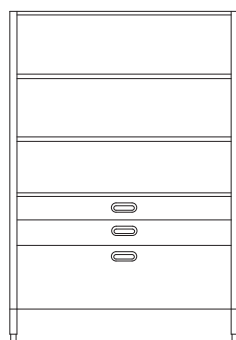

3C3R/128-185-50 6.900
3C3R/128-185-64 7.540

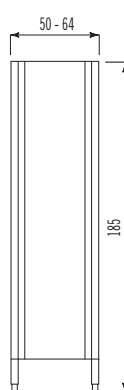

Fianchi e posteriore non sono previsti negli elementi con soli ripiani. I ripiani sono regolabili in altezza.
Elements with shelves only do not feature any side or back walls. The shelves in the storage elements are height adjustable.

Schienali in acciaio inox a muro H. 4
Stainless steel wall mounted backboards H. 4

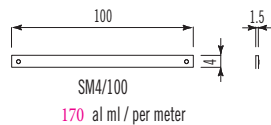

170 al ml / per meter

Schienali in acciaio inox a muro H. 30
Stainless steel wall mounted backboards H. 30

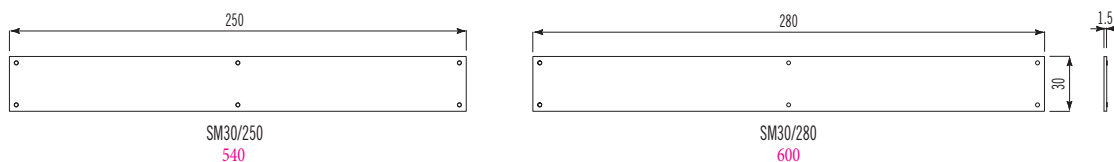
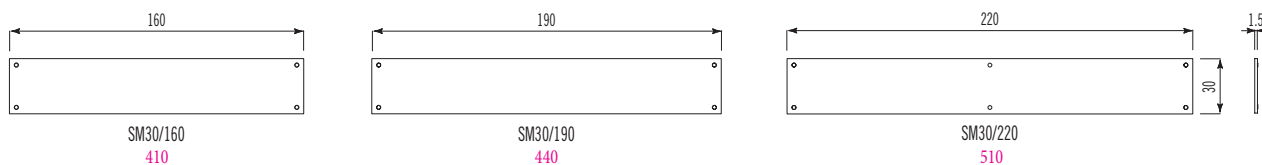
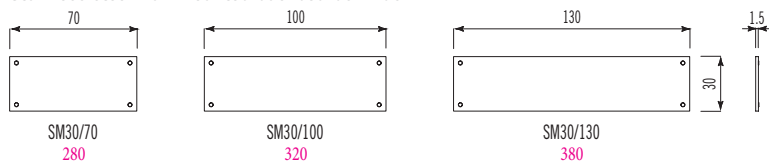

Schienali in acciaio inox a muro H. 70
Stainless steel wall mounted backboards H. 70

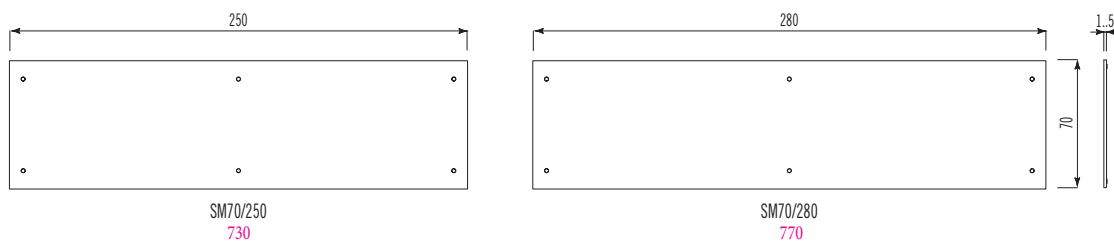
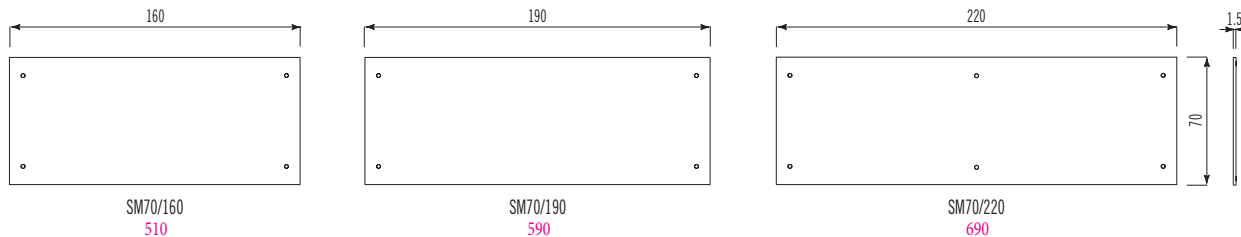
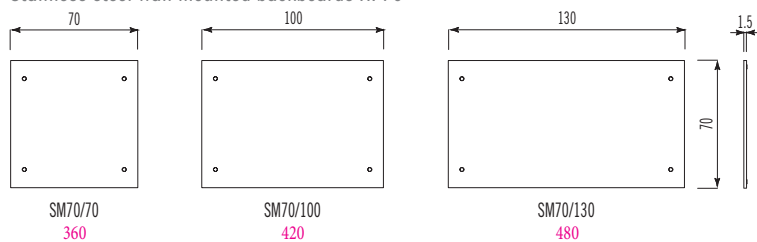

ACCESSORI

ACCESSORIES

Carrelli Kitchen carts

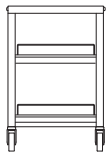

CA 80
3.320



CA 80/1C
3.880

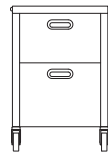

CA 80/2C
3.830



CA 80/3C
3.980

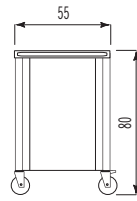

Specificare se con top inox o ceppo in legno.
Please specify if with steel countertop or wooden chopping block.

Maggiorazione ceppo in legno.
Surcharge for wooden chopping block.

250

Portamestoli Kitchen ladle holder

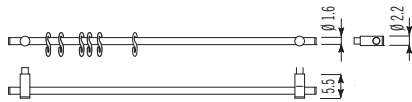

PMT
150 al metro / per meter

Maniglie laterali per elementi profondità 65 e 125 cm Side handles for elements with depth 65 and 125 cm

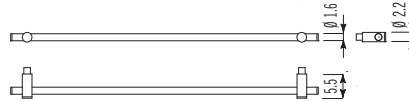

MN65 250
MN125 320

Torretta a scomparsa in acciaio inox con tre prese elettriche per top

Retractable three socket connector
in stainless steel for countertop

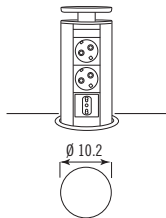

TPE
480

Modulo cablato a scomparsa in acciaio inox con due prese elettriche

Concealed module in stainless
steel with two electric sockets

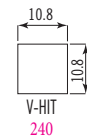
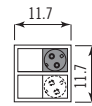

V-HIT
240

Mensole da parete in acciaio inox Stainless steel wall shelves

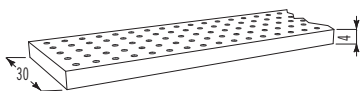

MP 610 al metro / per meter

MPL con striscia luminosa a led with led strip

800 al metro / per meter

Ruote Wheels



Le ruote possono essere applicate a tutti gli elementi freestanding.

La versione con ruote non varia il prezzo dell'elemento.

All the freestanding elements can be supplied with the wheels.

The price of the element doesn't change in the wheeled version.

OUTDOOR

OUTDOOR

Elementi su ruote con piastra di cottura

Elements on wheels with cooking plancha

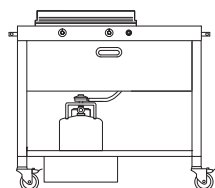
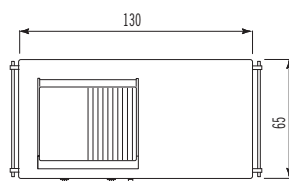
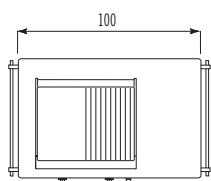

FT/100
7.370

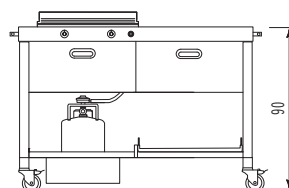

FT/130
8.900

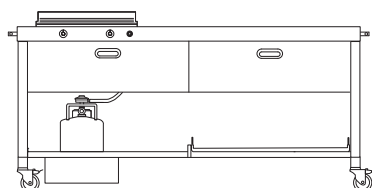
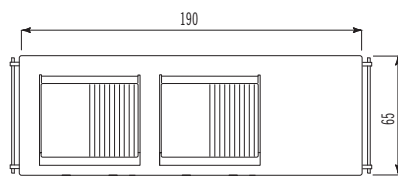
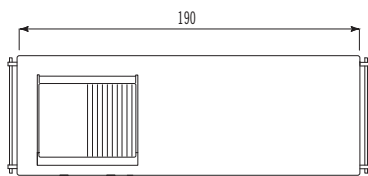

FT/190-1
9.970

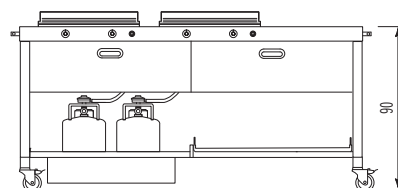

FT/190-2
12.160

Fori su top inox
Cutout holes on the
s/steel countertop

un foro incasso per
lavaggio o cottura
one built-in hole for a
washing or cooking items

160

un foro incasso filo piano per
piani cottura a induzione one
built-in hole for
flush-mount induction hobs

270

un foro e saldatura per
lavaggio
one hole and welding for
washing items

920

un foro per piani cottura
ribaltabili
one hole for flip-up
hobs

100

Coperture di protezione in poliestere
Polyester protective covers

larghezza 100 cm CP 100 330
100-cm lenght

larghezza 130 cm CP 130 360
130-cm lenght

larghezza 190 cm CP 190 410
190-cm lenght



Per configurazioni con elettrodomestici aggiuntivi, fare riferimento al listino "Strumenti d'Oggi".
For configurations with further appliances, please consult the "Strumenti d'Oggi" price-list.

acciaio inox stainless steel



L'acciaio è la materia prima delle nostre cucine, da plasmare per esaltarne la funzionalità e da ammirare per il piacere degli occhi. Steel is the raw material we use in our kitchens, shaped to highlight its functionality and admirable for its sheer beauty.

prezioso I prodotti Alpes sono trattati con satinatura "argento" per esaltare le loro forme con la tonalità lucente tipica del metallo prezioso.

elegante La bellezza dell'acciaio inox ben si abbina ad ogni tipo di materiale ed a ogni stile progettuale.

pratico Ben lungi dai luoghi comuni, l'acciaio è facile e pratico da pulire. Le superfici inox non si deteriorano dopo frequenti lavaggi, perché non presentano rivestimenti superficiali di protezione, come invece molti altri materiali.

duraturo La resistenza all'azione di detersivi, solventi e disinfettanti consente un'azione energica e accurata durante la pulizia. L'acciaio è un materiale anticorrosivo e resistente agli shock termici e mantiene inalterati il suo aspetto e le sue caratteristiche per decenni.

igienico La compattezza superficiale e priva di porosità dell'acciaio indica che non rilascia e non assorbe sostanze di alcuna natura. Non si scheggia, non si usura, non si incrina e non si deteriora, impedendo la formazione di discontinuità superficiali che si trasformerebbero in ricettacoli per germi e sporcizia.

precious Alpes products are treated with a "silver" satin finish to highlight their forms with the typical luster of precious metal.

elegant The beauty of stainless steel is a fine match for any type of material and any design style.

practical Contrary to commonly-held notions, steel is practical and easy to clean. Stainless steel surfaces do not deteriorate after frequent washings, because they do not have protective surface treatments, like many other materials do.

lasting Their resistance to detergents, solvents and cleaners allows a precise and energetic cleaning action. Steel is a non-corroding material that resists thermal shock and whose appearance and characteristics remain unaltered for decades.

hygienic The compact and non-porous surface of steel proves that it neither releases nor absorbs substances of any kind. It does not chip, it does not wear down, it does not crack and does not decay, preventing the formation of irregularities in the surface that could create pockets of bacteria and dirt.

pulizia dei materiali

cleaning the materials

_acciaio inox

cosa non fare Non pulire i piani d'acciaio con pagliette, spazzole metalliche, detersivi abrasivi o in polvere che possano intaccare la superficie liscia, rigandola irrimediabilmente. Assolutamente da abolire i detersivi a base d'acido clorico, fluoridrico, fosforico e muriatico. Anche il semplice contatto dei loro vapori acidi può avere un'azione ossidante e corrosiva sull'acciaio inox! Lo stesso vale per acidi a base d'ipoclorito di sodio, candeggina o ammoniaca, contenuti generalmente nei detersivi per l'igiene della casa.

cosa fare Il sistema più efficace è sempre il più semplice. Tutte le superfici d'acciaio inox vanno trattate con acqua e sapone, o detersivo neutro, risciacquate abbondantemente e asciugate con un panno morbido. I depositi di **calcare** e d'acqua stagnante si eliminano con creme detersivi specifiche per l'acciaio, oppure con una soluzione casalinga di acqua calda mista ad aceto bianco, risciacquata a sua volta da acqua pulita. Si asciuga con cura e del calcare si è persa ogni traccia. Il rimedio migliore per rimuovere **olio e grasso** è utilizzare un prodotto liquido per piatti diluito con acqua molto calda. Sciacquare e asciugare con un panno morbido. Sulle macchie più ostinate ripassare con un panno imbevuto d'alcool.

_corian®

Atossico e non poroso, il Corian® offre caratteristiche che lo rendono ideale per i piani di lavoro. Facile da pulire e mantenere in buone condizioni, Corian® evita la proliferazione di muffe e batteri.

per la pulizia quotidiana utilizzare un panno umido con una crema abrasiva leggera o un comune detersivo. Agire sempre con un movimento circolare. Anche se i liquidi non possono penetrare all'interno del Corian®, è meglio eliminarli subito.

Macchie prodotte da caduta di liquidi come aceto, caffè, tè, succo di limone, coloranti, ketchup, vino rosso o oli vegetali: prima passare un panno umido con una crema abrasiva leggera e poi usare progressivamente una spugna abrasiva e un detersivo o una soluzione per la pulizia delle superfici a base di ammoniaca. Solo in presenza di macchie particolarmente tenaci o di un graffio significativo sarà possibile utilizzare una spugna abrasiva con della candeggina. Risciacquare parecchie volte con acqua calda ed asciugare con un panno morbido. Per ridare l'aspetto originale passare un panno umido e una crema abrasiva leggera sull'intera superficie del piano con un movimento circolare.

Calore non posare mai tegami caldi o roventi direttamente sul piano di lavoro di Corian®.

Graffi come qualsiasi materiale, presenterà leggeri segni di abrasione a seguito del normale uso quotidiano. Evitare di tagliare o tritare direttamente su Corian®.

Le macchie accidentali di sostanze chimiche come sverniciatori, prodotti per la pulizia dei metalli o dei forni, prodotti contenenti cloruro di metilene, acidi, prodotti a base di acetone, ecc., devono essere prontamente eliminate con una abbondante quantità di acqua e sapone.

_ceppi in legno

Il ceppo di legno va pulito esclusivamente con un panno umido.

Il trattamento ideale idrorepellente sarebbe spalmare periodicamente il legno con olio ad uso alimentare, al fine di limitarne l'assorbimento d'acqua senza alterare le proprietà organolettiche dei cibi che ne vengono a contatto. Il sole o le fonti di calore a diretto contatto con il legno possono alterarne il colore.

_stainless steel

what not to do Do not clean steel surfaces with steel pads, metal brushes, abrasive or powder detergents that could damage the polished surface, scratching it irreparably. Absolutely prohibited are detergents based on chloric, hydrofluoric, phosphoric and muriatic acids. The mere contact of their acid vapors can have an oxidizing and corrosive action on stainless steel! The same is true for acids based on sodium hypochlorite, bleach or ammonia, generally present in detergents for the home.

what to do The most effective system is always the simplest. All steel surfaces should be washed with soap and water, or neutral detergents, rinsed with abundant water and dried with a soft cloth. **Lime** deposits and stagnant water may be removed with specific cream detergents for steel, or with a home-made solution of warm water and white vinegar: clean then rinse with clean water. Dry carefully and there will no more trace of lime. The best remedy to clean **oil and grease** is to use liquid dish soap diluted with very hot water. Rinse and dry with a soft cloth. The most stubborn stains may be removed with a soft cloth imbued in alcohol.

_corian®

Corian® is non-toxic and non-porous, just two of the characteristics that make it ideal for worktops. Easy to clean and keep in good condition, Corian® prevents the proliferation of mould and bacteria.

For everyday cleaning, just use a damp cloth and a mild cream abrasive cleanser or a common household degreaser. Always clean using a circular motion. Although liquids cannot penetrate Corian®, it is best to wipe up spills as they occur.

Common household spills, such as vinegar, coffee, tea, lemon juice, dyes, ketchup, red wine or vegetable spills: First, try to clean with a damp cloth and a mild cream abrasive, then progress with an abrasive plastic scouring pad and a detergent or an ammonia based hard-surface cleaner. Only with a really persistent stain as lily pollen, or saffron, or with a light scratch, should you need to resort to an abrasive plastic scouring pad and rub over the stain with some bleach. Rinse several times with warm water and dry with a soft cloth. Always restore the overall luster afterwards, using a damp cloth and a mild cream abrasive cleaner and blend the scrubbed area into the entire surface by rubbing in a circular motion.

Heat Never put hot pans directly on a Corian® top.

Scratches Like all materials it will develop slight abrasion marks in normal daily use. Never cut or chop on Corian®.

Accidental spills of strong chemicals (e.g. paint stripper, brush cleaners, metal cleaners, oven cleaners, cleaners containing methylene chloride, acid drain cleaners, acetone-based nail varnish removers etc.) should be flushed promptly with plenty of soapy water to avoid damaging worktops.

_wood chopping board

The wood chopping board should be cleaned exclusively with a damp cloth.

The ideal waterproofing treatment would be to periodically treat the wood with food oil, so that it limits the absorption of water without altering the organic properties of the food that comes into contact with it.

The sun and other heat sources in direct contact with the wood can alter its colour.

condizioni generali di vendita general sales condition



I prezzi del presente listino sono espressi in Euro e non sono comprensivi di I.V.A.

The prices in this list are in Euros. The VAT is not included

Con la trasmissione dell'ordine il cliente accetta tutte le condizioni contenute nei seguenti articoli:

1. tutti i prezzi, misure, descrizioni pubblicati nel presente listino possono essere variati o annullati in qualunque momento e senza preavviso, in base alle esigenze tecniche e commerciali di Alpes-Inox S.r.l. e ciò senza possibilità di rivendicazioni da parte dell'acquirente;
2. Alpes-Inox S.r.l., in qualsiasi momento e senza preavviso, si riserva il diritto di non produrre più alcuni articoli di gamma;
3. i termini fissati per la consegna non sono tassativi e in nessun caso possono giustificare ritardi di pagamento o dare luogo a risarcimento di danni;
4. l'imballo è eseguito con scatole di cartone e gabbie in legno gratuite;
5. la merce è venduta franco fabbrica e viaggia sempre a rischio e pericolo del committente. La spedizione verrà effettuata nel modo ritenuto più opportuno senza che ciò possa dar luogo a reclami di sorta. In modo tassativo non verranno riconosciuti e accordati bonifici, sostituzioni, accrediti, ecc. per ammanchi, rotture o altro, in dipendenza dei trasporti o imballi poichè ogni spedizione deve intendersi eseguita per ordine e conto del cliente. La verifica della qualità e del tipo di merce deve essere fatta dal compratore alla consegna. Qualunque richiesta o contestazione da parte del destinatario in ordine a quanto sopra ed anche per il caso di ritardi o disguidi, deve essere rivolta direttamente ai vettori responsabili;
6. vengono considerati liberatori soltanto i pagamenti in valuta legale, o con altro mezzo convenuto, esclusa ogni riduzione o arrotondamento, alle scadenze stabilite nelle fatture. In caso di ritardato pagamento, verranno addebitati gli interessi di mora. Detti interessi decorreranno dal giorno successivo alla scadenza, senza bisogno di particolari diffide. È facoltà di Alpes-Inox S.r.l. sospendere le consegne, o annullare ordini già accettati, qualora i pagamenti non vengano effettuati alle scadenze stabilite. Contestazioni di qualunque genere non danno diritto a differire o sospendere i pagamenti;
7. le condizioni di garanzia sono riportate nel certificato inserito nella confezione corrispondente ad ogni apparecchiatura;
8. per qualsiasi contestazione è sempre e solo competente l'Autorità Giudiziaria di Bassano del Grappa (VI).

Il presente listino annulla e sostituisce ogni precedente listino, offerta o comunicazione di prezzo sia verbale che scritta.

Upon placing the order, the customer accepts all the conditions specified in the following clauses:

1. All prices, measurements and descriptions contained in this price list can be changed or cancelled by the manufacturer at any time without prior notice, according to the technical and commercial needs of Alpes-Inox S.r.l., and without the possibility of claims from the buyer.
2. Alpes-Inox reserves the right to stop production of any article, at any time and without prior notice.
3. The delivery terms are not binding and in no case shall they justify delays in payment or lead to claims for damages.
4. Packaging is done in cardboard boxes and wooden crates, free of charge.
5. The goods are sold ex-works and travel at the purchaser's risk. The shipping will be done in the most suitable manner and no claims will be acknowledged. No compensation, replacement or credit will be granted for any shortfall, damage, breakage or other loss arising out of the carriage or packaging, since each shipment shall be considered carried out upon the customer's order and on his/her behalf. The purchaser shall check the quality and type of goods immediately upon receipt. Any requests or complaints whatsoever by the consignee regarding the above or in case of delays or inconvenience, must be directly addressed to the carriers.
6. Only payments made in legal currency or by other means previously agreed upon are considered as redeeming on the deadlines stated in the invoice, excluding any price reductions or rounding off. In case of delayed payment, overdue interest will be charged. Said interest will start as from the day following the due date, without any notice by the seller being required. It is the right of Alpes-Inox S.r.l. to stop delivery or cancel any orders already accepted in case payments are not made according to the agreed due dates. No claims whatsoever shall give the purchaser the right to defer or stop payments.
7. The warranty conditions are stated in the certificate enclosed in the package.
8. For any controversy, competent jurisdiction lies with the Court of Bassano del Grappa, Vicenza, Italy.

This price list cancels and replaces any previous price list, offer or price communicated either verbally or in writing.

